

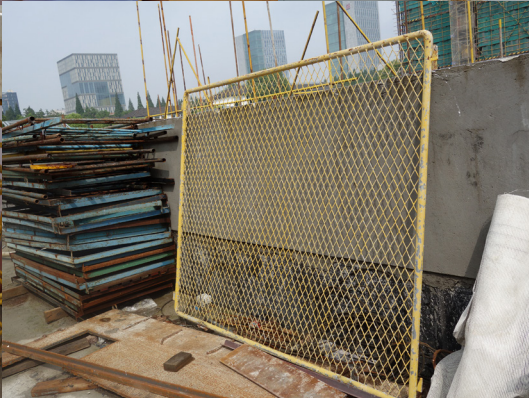

# Farming Constructionsite









- **Theme: Construction-Site Design**
- **Target: Peasant Worker**
- **Goals: Optimize their workspace through;**
  - Provide fresh food**
  - Balance the temperature in their shelters**
  - Reduce pollution and dust**
- **Demand:**
  - Afordable**
  - Easy to build**
  - Materials from construction-site**



# Offering Map





# System Map

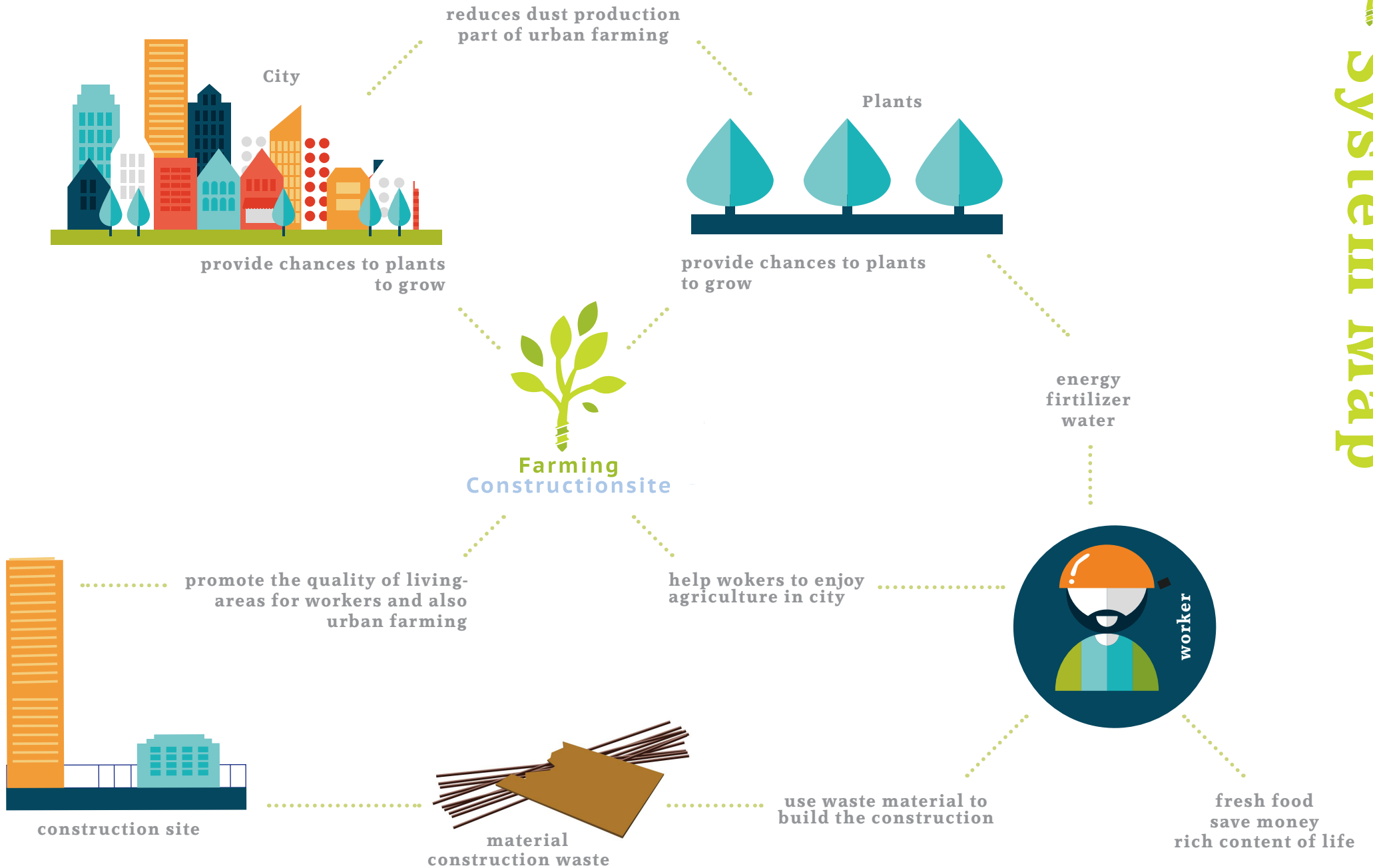



# Analysis

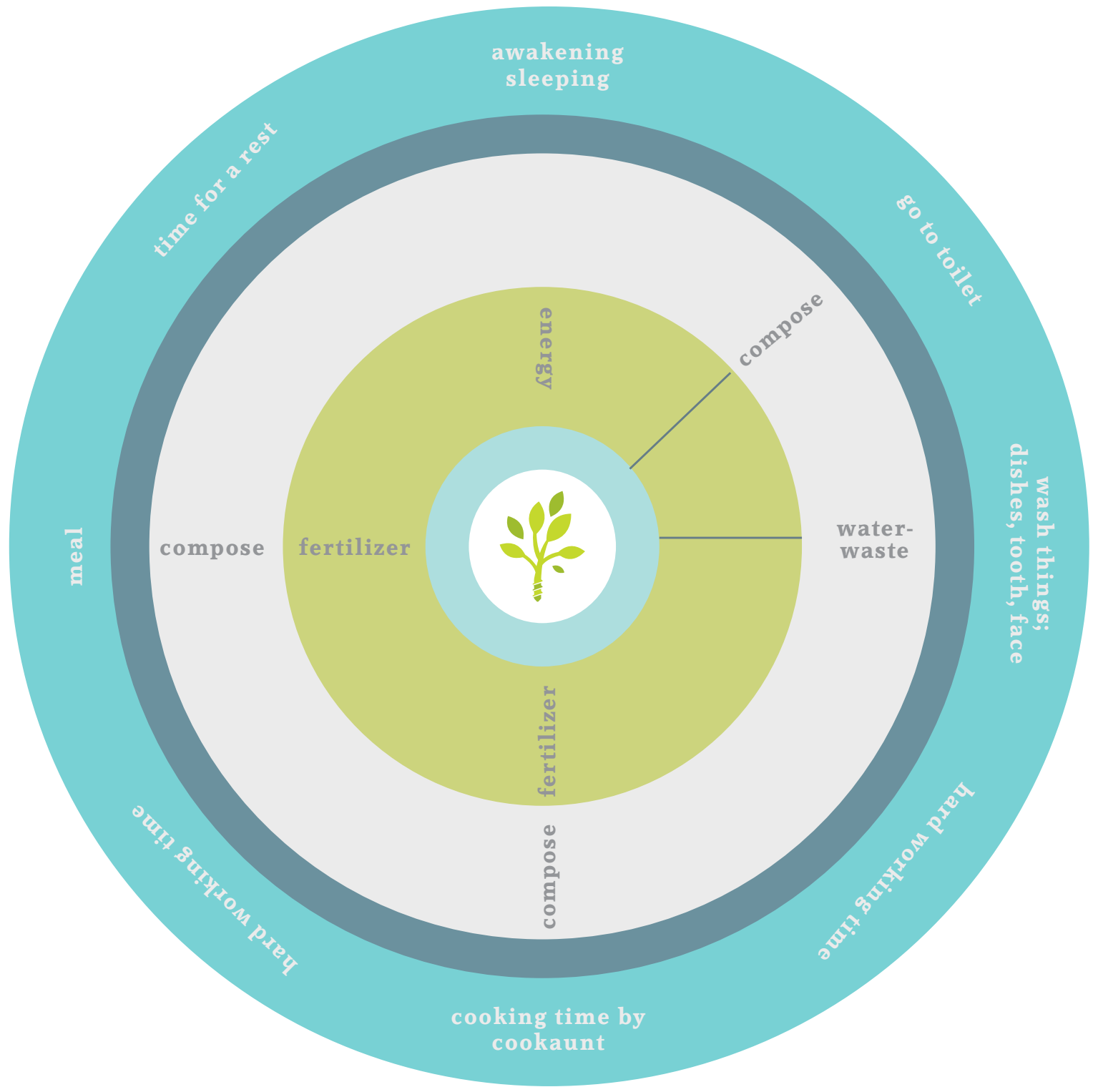



# Analysis

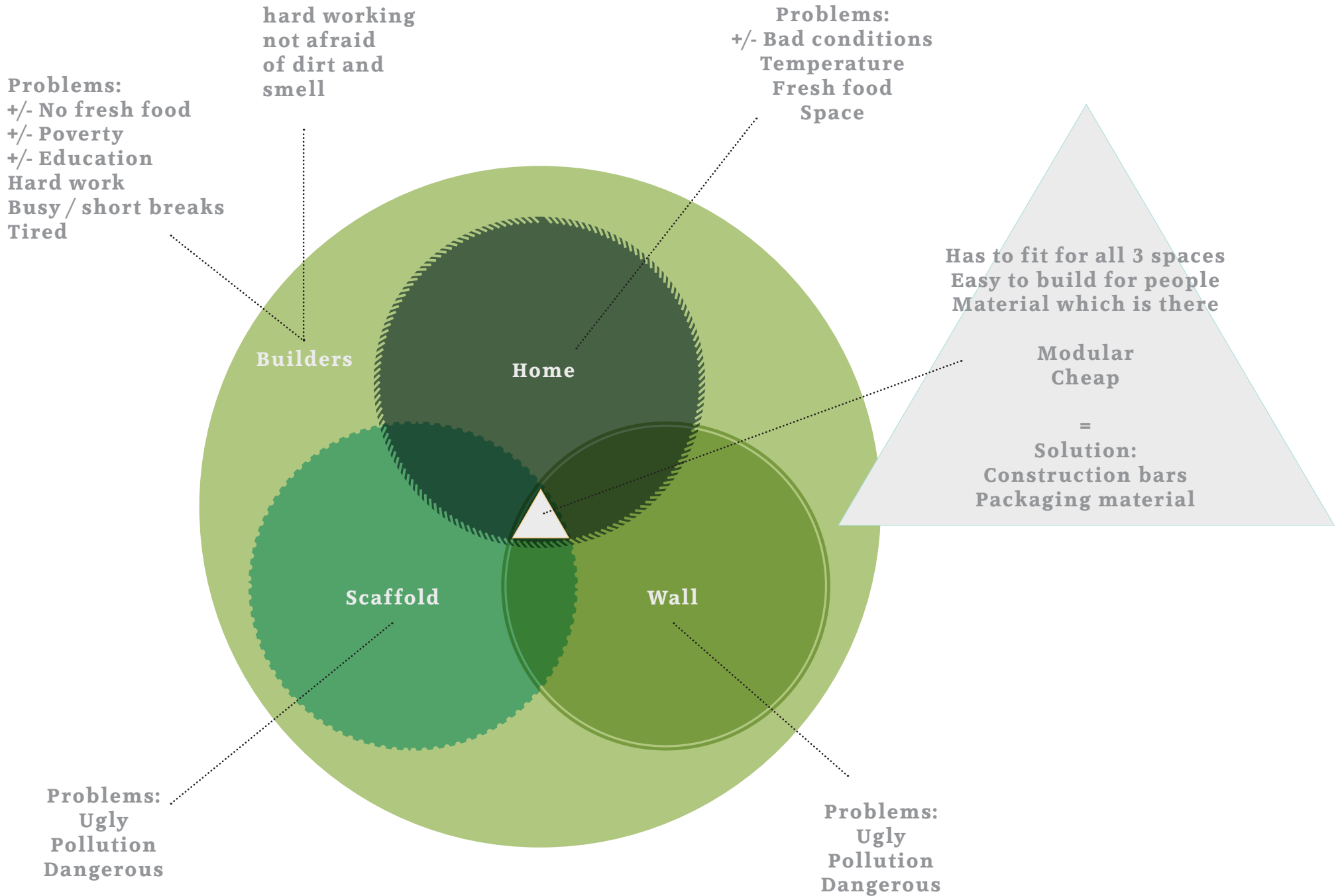



# Tools



disposable materials at the construction site – maybe we can use this material to farm



# PROTOTYPE



THE WALL HERE



THE FLOATING WATER



THE BOX HERE



THE FRAME HERE

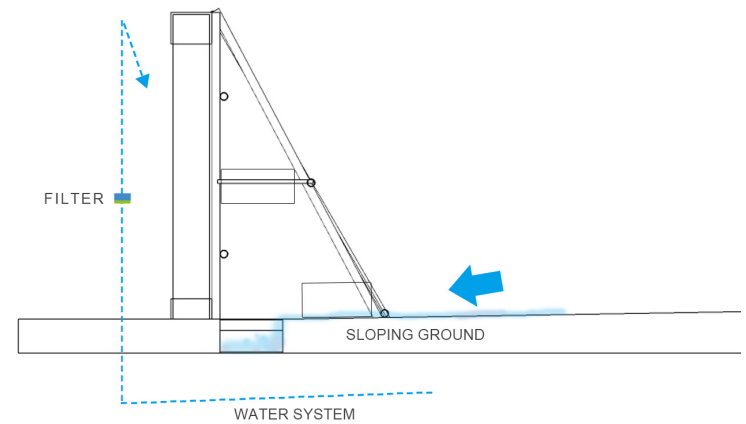
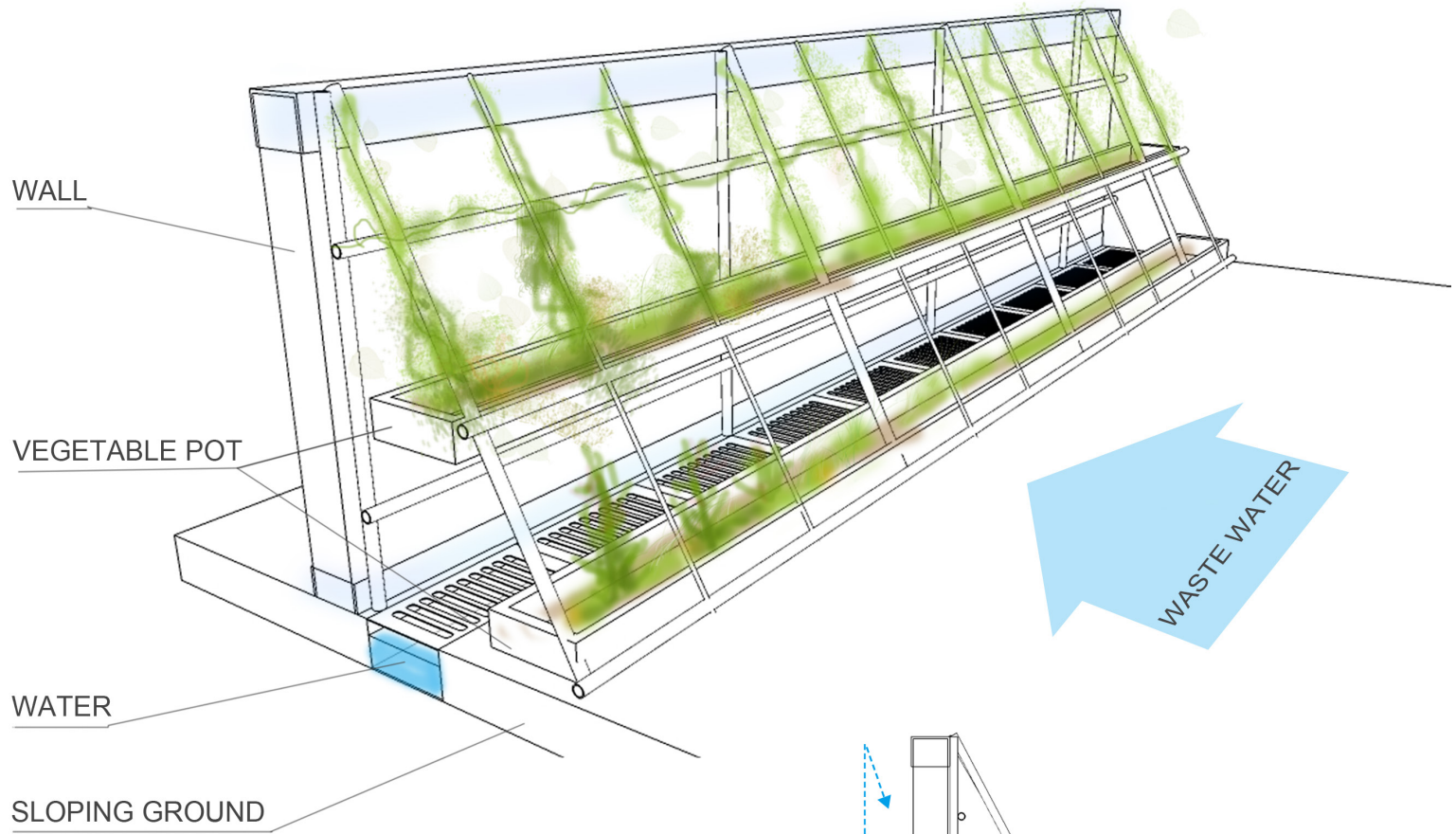

# PROTOTYPE

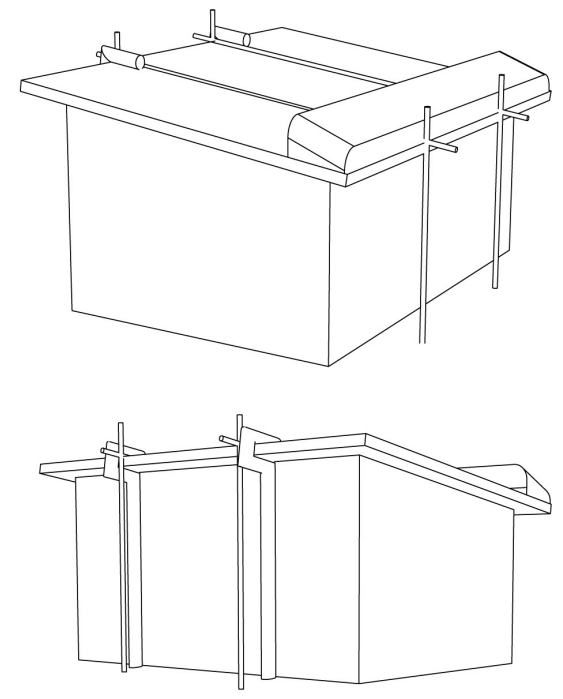
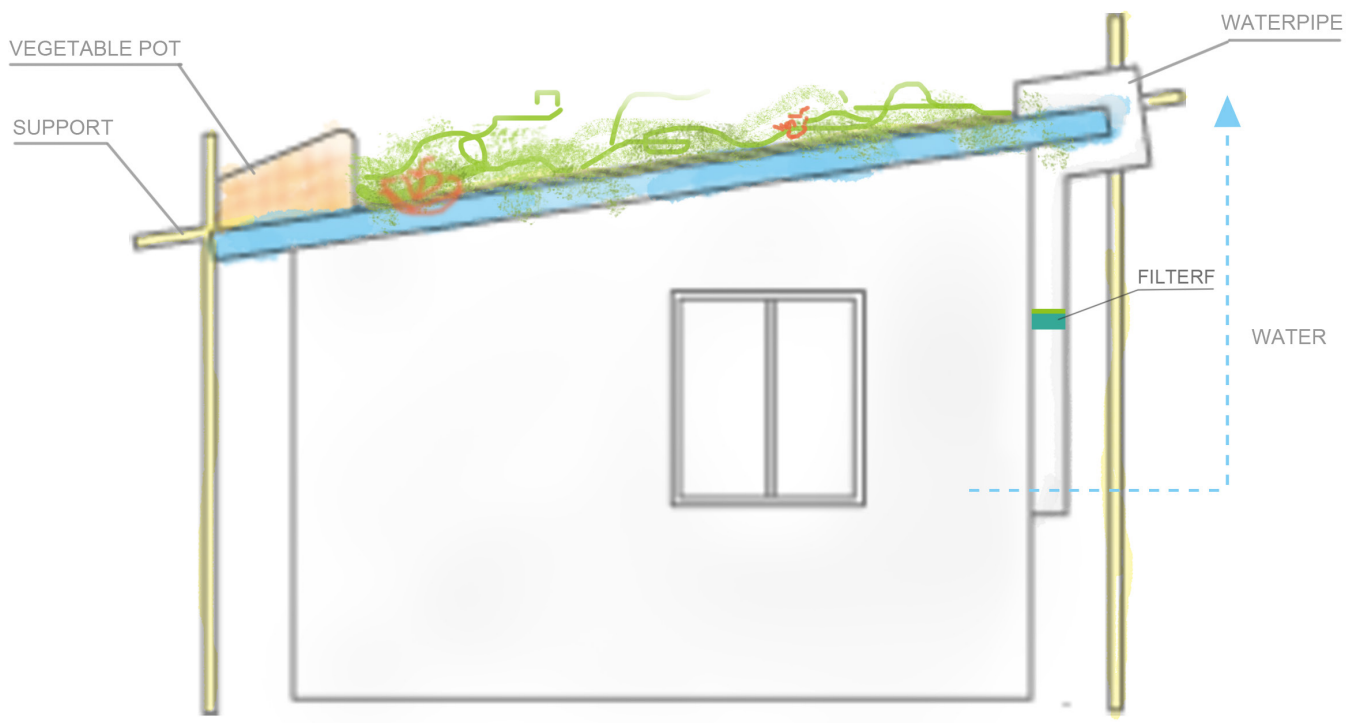

  
**Prototype 2**



THE BOARD ROOM  
CONSTRUCTION  
REFERENCE



# Prototype 1

## PROTOTYPE

WHERE THEY CAN HAVE A REST,  
MAYBE HAVE A LUNCH

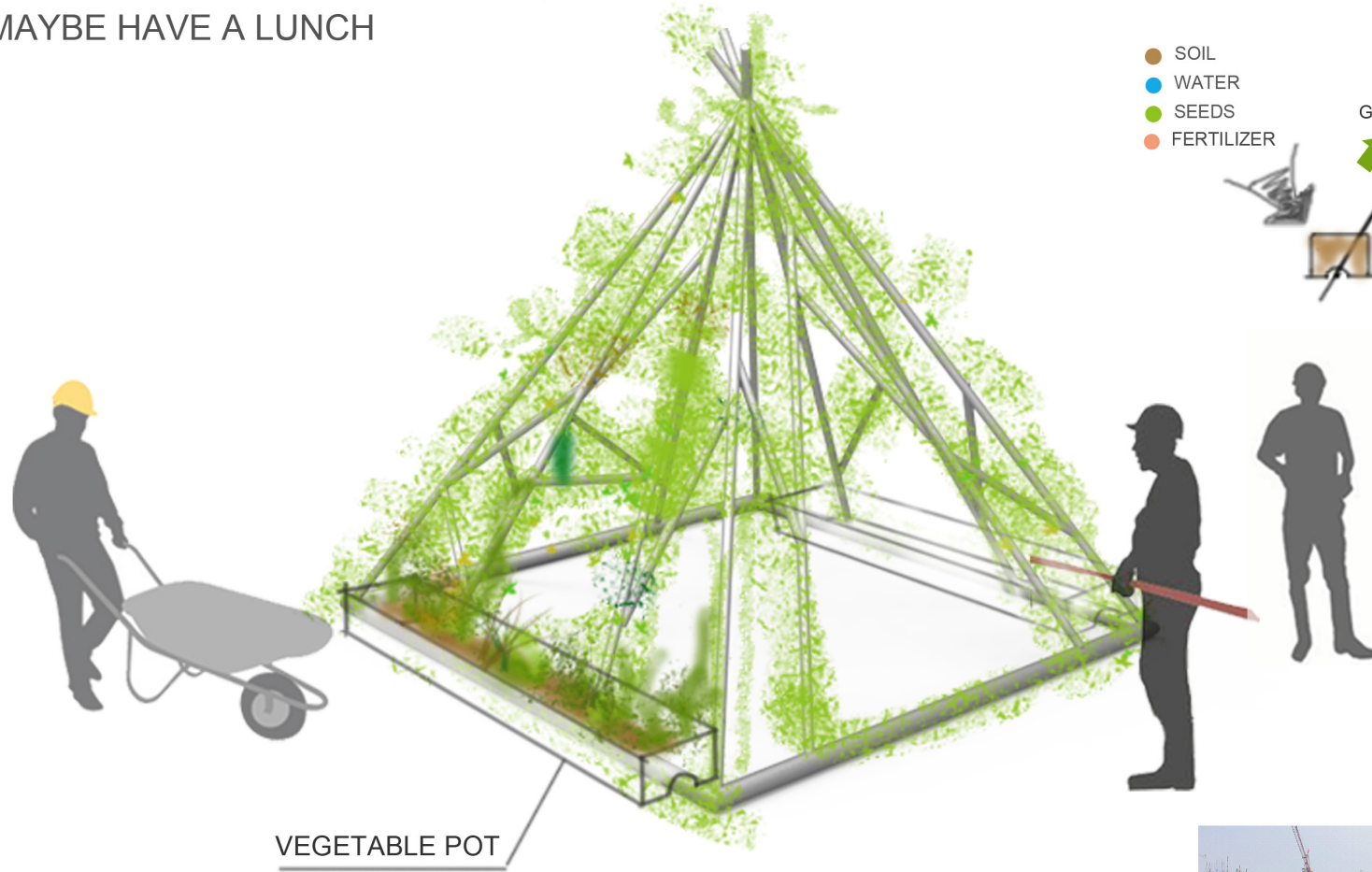

- SOIL
- WATER
- SEEDS
- FERTILIZER

GROW

GROW







## **Mona says:**

能和不同学校和不同国家的小伙伴一起完成这个summer school，是一段新奇的经历  
It is a very nice and new experience to work with friends come from different school and different country

## **Summer says:**

享受过程，分享经历，感受不同的文化，和小伙伴开心的一起工作，留下一段珍贵的回忆  
enjoy process ,share experience,feeling different culture ,we work together happily .give me a precious memory

## **Andrea says:**

The Workshop was nice, but the toppic was not very clear – that made it a little dificult..  
I had a very good time, thanks to my teammates <3